

TO-92 Plastic-Encapsulate Transistors

Features

- Power dissipation
- TRANSISTOR (NPN)

MECHANICAL DATA

- Case style: TO-92 molded plastic
- Mounting position: any

TO-92

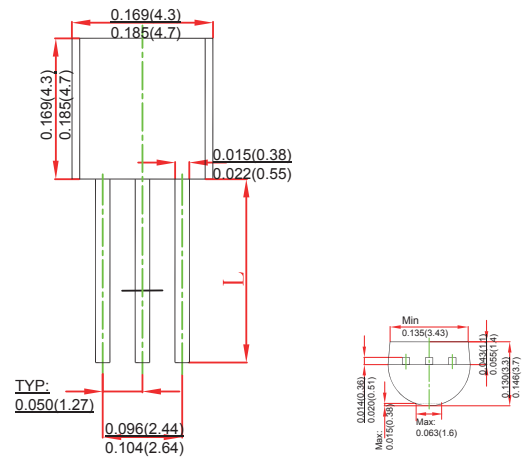

MAXIMUM RATINGS AND CHARACTERISTICS

@ 25°C Ambient Temperature (unless otherwise noted)

Symbol	Parameter	Value	Unit
V_{CBO}	Collector-Base Voltage	BC337 50	V
		BC338 30	
V_{CEO}	Collector-Emitter Voltage	BC337 45	V
		BC338 25	
V_{EBO}	Emitter-Base Voltage	5	V
I_C	Collector Current -Continuous	800	mA
P_D	Total Device Dissipation	625	mW
T_j	Junction Temperature	150	°C
T_{stg}	Storage Temperature	-55-150	°C

ORDERING INFORMATION

Part Number	Package	Packing Method	Pack Quantity
BC337	TO-92	Bulk	1000pcs/Bag
BC337-TA	TO-92	Tape	2000pcs/Box
BC338	TO-92	Bulk	1000pcs/Bag
BC338-TA	TO-92	Tape	2000pcs/Box

Parameter	Symbol	Test conditions	MIN	TYP	MAX	UNIT
Collector-base breakdown voltage	V_{CBO}	$I_C = 100\mu A, I_E = 0$	50			V
			30			V
Collector-emitter breakdown voltage	V_{CEO}	$I_C = 10mA, I_B = 0$	45			V
			25			V
Emitter-base breakdown voltage	V_{EBO}	$I_E = 10\mu A, I_C = 0$	5			V
Collector cut-off current	I_{CBO}	$V_{CB} = 45V, I_E = 0$ $V_{CB} = 25V, I_E = 0$			0.1	μA
					0.1	μA
Collector cut-off current	I_{CEO}	$V_{CE} = 40V, I_B = 0$ $V_{CE} = 20V, I_B = 0$			0.2	μA
					0.2	μA
Emitter cut-off current	I_{EBO}	$V_{EB} = 4V, I_C = 0$			0.1	μA
DC current gain	$h_{FE(1)}$	$V_{CE} = 1V, I_C = 100mA$	100		630	
			100		250	
			160		400	
			250		630	
Collector-emitter saturation voltage	$V_{CE(sat)}$	$I_C = 500mA, I_B = 50mA$			0.7	V
Base-emitter saturation voltage	$V_{BE(sat)}$	$I_C = 500mA, I_B = 50mA$			1.2	V
Base-emitter voltage	V_{BE}	$V_{CE} = 1V, I_C = 300mA$			1.2	V
Transition frequency	f_T	$V_{CE} = 5V, I_C = 10mA$ $f = 100MHz$	210			MHz
Collector Output Capacitance	C_{ob}	$V_{CB} = 10V, I_E = 0$ $f = 1MHz$		15		pF

Type	BC337	BC338
Marking	BC337	BC338

RATINGS AND CHARACTERISTIC CURVES

Typical Characteristics

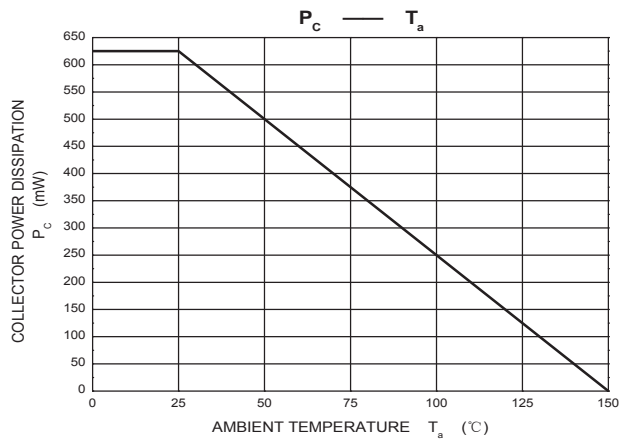
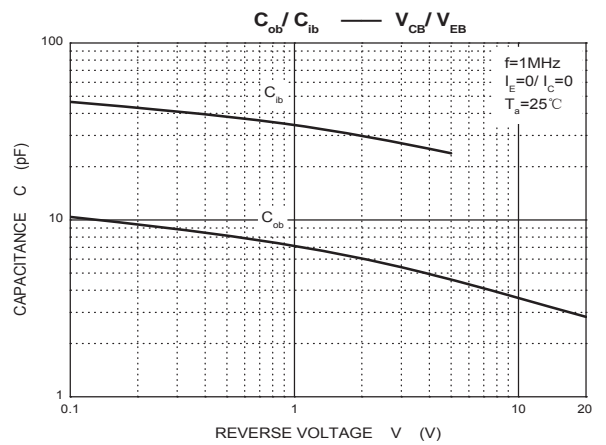
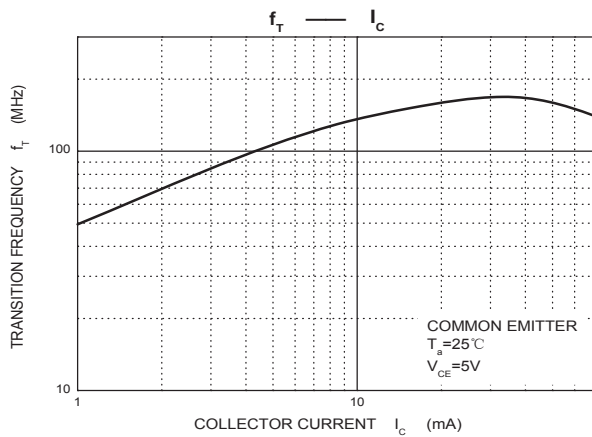
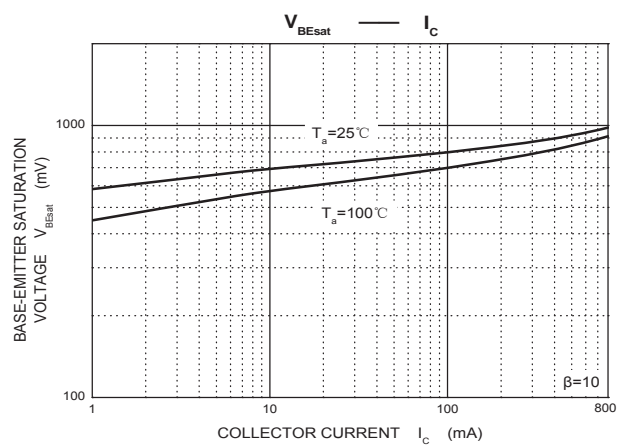
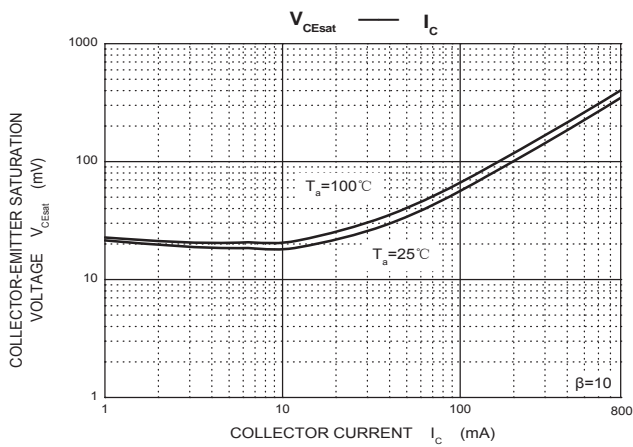
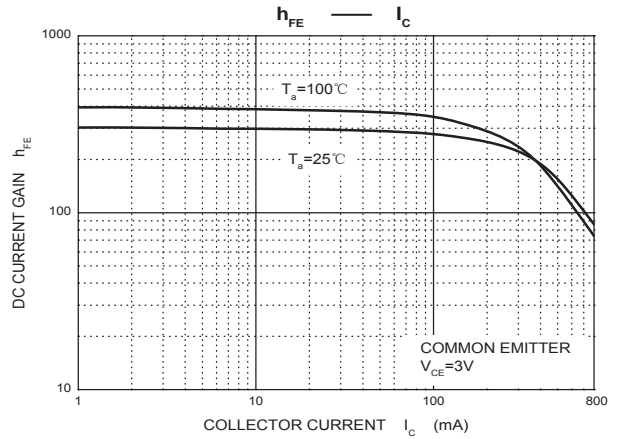
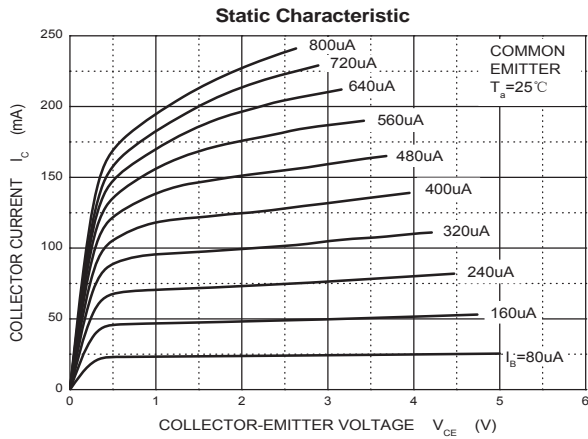

TO-92 PACKAGE TAPEING DIMENSION

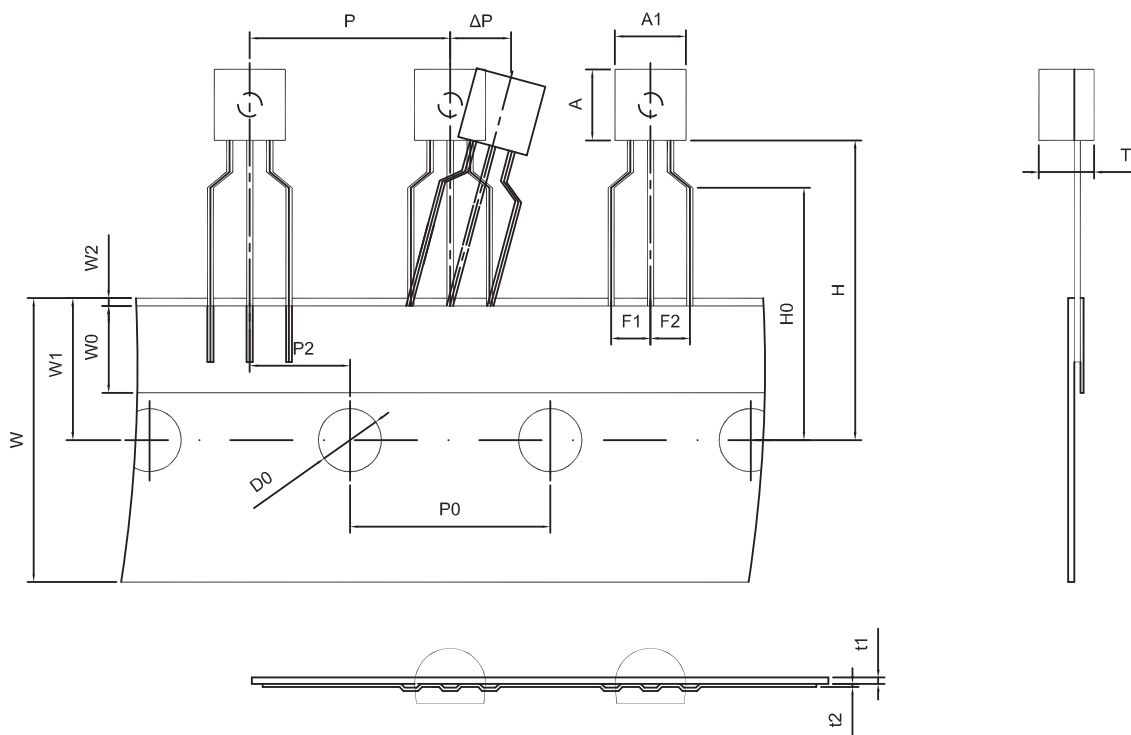

Dimensions are in millimeter								
A1	A	T	P	P0	P2	F1	F2	W
4.5	4.5	3.5	12.7	12.7	6.35	2.5	2.5	18.0
W0	W1	W2	H	H0	D0	t1	t2	ΔP
6.0	9.0	1.0 MAX.	19.0	16.0	4.0	0.4	0.2	0

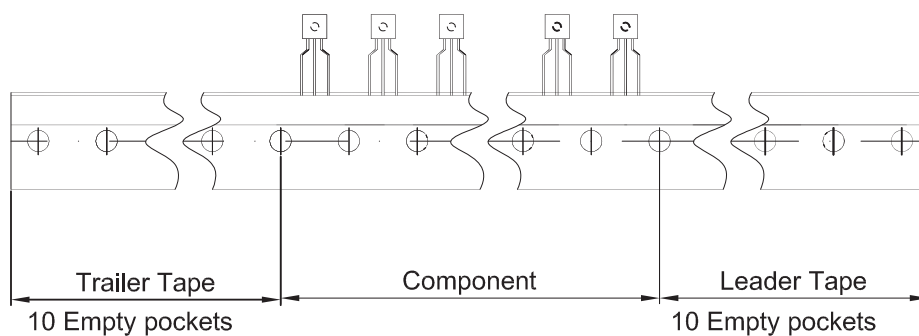

Package	Box	Box Size(mm)	Carton	Carton Size(mm)
TO-92	2000 pcs	333×162×43	20,000 pcs	350×340×250